



# HAND PUMPS



Pump Flange



11 HA Hand Pump



Drinking Fountain Pump



11 HD Force Pump



Cylinders



12HD Force Pump



Spouts



**LIFT PUMP STAND** – for Hand Pump use. (11HA) is recommended for shallow wells less than 25 feet, has a 6 inch stroke only and a multi-position cap. The 11HA pump does not have a sealed packing in the top of the pump and is therefore more suitable for watering flowers and livestock than for drinking water.

**FORCE PUMP STANDS**– for Windmill, Pump Jack or Hand Pump use. These Force Pumps have a built-in surge chamber, piston rod and packing nut, adjustable strokes and multi-position cap. Order (11HD) for siphon spout or (12HD) for bibb spout models. Force Pumps are available with factory installed sanitary shroud. Can be used to depths of 200 feet.

For more information contact:  
Baker Water Systems  
Phone: 800-356-5130  
e-mail: [monitor@baker-mfg.com](mailto:monitor@baker-mfg.com)  
[www.baker-mfg.com](http://www.baker-mfg.com) | [www.campbellmfg.com](http://www.campbellmfg.com)



## HAND PUMP SYSTEMS SELECTION GUIDE

### SELECTING THE HAND PUMP

#### Model 11HA

This is the most basic hand pump. Not to be used if cylinder is to be set more than 25 feet.

**NOTE:** The 11HA does not have a sealed packing in the top of the pump and is therefore more suitable for watering flowers and livestock than for drinking water.

#### Model 11HD

The most popular hand pump in America. With its sealed packing, it's the ideal pump for drinking water.

#### Model 12HD

Same as the 11HD except with bibb spout. This means that the spout can be shut off in the event that you want to pump water out the back of the pump only. In other words, you can "force" water to a tank, pond, reservoir, etc. by piping out the back of the pump.

#### Model 146HD

An adapter that can be quickly attached to the spout of the 11HD or 12HD force pump and allows you to attach a garden house.

### SELECTING THE PUMP FLANGE

The pump flange attaches to the well. The hand pump attaches to the pump flange. You must provide the nuts, bolts and washers (available at your hardware store) to connect the pump to the pump flange.

Measure the inside diameter of your well casing and then select the appropriate pump flange. 4", 5" or 6" only.

The standard pump flange will suffice in most cases. If you are especially concerned about contamination, order the sealed flange.

Although the pump flange is not required to complete a functional hand pump system, it is highly recommended to stabilize the hand pump and prevent any rocking motion.

### SELECTING THE CYLINDER

This is the part of the system that goes down the well typically below the water table. It's a barrel with a plunger inside. When you pump on the handle of the hand pump, it makes the cylinder plunger go up and down. This forces the water up the pipe and out the hand pump.

To select the cylinder, go to the Table of Hand Pump Data. See the column titled "Cylinder Size"? That refers to the I.D. (inside diameter) of the cylinder. Cylinders are referred to by their I.D.

Now read across until you reach the depth-to-water (not the total depth of your well) that comes closest to your installation. This tells you what I.D. cylinder you need.

For shallow wells, 25 feet or less to the water table, you may install the cylinder above the water table and attach a section of 1-1/4 inch pipe from the bottom of the cylinder. This section must extend below the water table.

Note that the 11HD and 12HD hand pumps have adjustable stroke settings on the handle. You can set them for the stroke you want. The shorter the stroke, the easier it is to pump.

**CAUTION:** Be sure that the O.D. (outside diameter) of the cylinder does not exceed the I.D. of the well.

### SELECTING THE PUMP ROD

The pump rod, sometimes referred to as sucker rod, provides the mechanical connection between the hand pump and the plunger in the cylinder. This means when you pump the hand pump, it makes the pump rod and plunger go up and down, delivering the water out the spout of the hand pump.

Pump rod is threaded and coupled and comes in 21' lengths. Order enough pump rod so that your cylinder is about 15' below water, for deep well applications.

**IMPORTANT:** Always order one additional rod coupling (besides what's on the pump rod). You'll need this extra rod coupling to make the final connection.

**NOTE:** You'll also need 1-1/4" X 21' lengths of pipe. This is the water supply line between the cylinder and the hand pump. This can be purchased from your local hardware store or plumber. Buy the same amount of pipe as you do pump rod. The pump rod is installed inside the pipe.

This is everything you need for your hand pump system. Assembly and installation instructions will come with your order.

**CAUTION:** Be sure and sanitize your well in accordance with your state codes and have your water tested before drinking the water.

**BE CAREFUL:** This is heavy equipment with sharp edges and pinch points.

**NOTE:** A 1/8" weep hole should be drilled in the drop pipe just below your frostline to prevent freezing.

For more information contact:  
Baker Water Systems  
Phone: 800-356-5130  
e-mail: [monitor@baker-mfg.com](mailto:monitor@baker-mfg.com)  
[www.baker-mfg.com](http://www.baker-mfg.com) | [www.campbellmfg.com](http://www.campbellmfg.com)



## HAND PUMPS

**LIFT PUMP STAND** – for Hand Pump use. (11HA) is recommended for shallow wells less than 25 feet, has a 6 inch stroke only and a multi-position cap. The 11HA pump does not have a sealed packing in the top of the pump and is therefore more suitable for watering flowers and livestock than for drinking water.

**FORCE PUMP STANDS**– for Windmill, Pump Jack or Hand Pump use. These Force Pumps have a built-in surge chamber, piston rod and packing nut, adjustable strokes and multi-position cap. Order (11HD) for siphon spout or (12HD) for bibb spout models. Force Pumps are available with factory installed sanitary shroud. Can be used to depths of 200 feet.



11HA

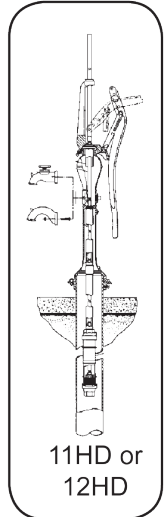

11HD or 12HD



12HD



11HD

### Monitor Lift Hand Pump Stands

Ord. No.	Description	Wt.
11HA	Hand lift pump stand	64
100HA	7' Drop Pipe & Rod Assembly, ONLY.	22
HA20	7/16" Plated Pump Rod 7' Long, Threaded both ends	4

### Monitor Force Pump Stands

11HD	Force Pump stand w/syphon spout	80
12HD	Force pump stand w/bibb spout	80
11HDA	Force Pump stand 2" w/syphon spout	80
12HDA	Force pump stand 2" w/bibb spout	80
11HDS	Force pump stand w/syphon spout & shroud	110
12HDS	Force pump stand w/bibb spout & shroud	110
11HDSA	Force pump stand 2" w/syphon spout & shroud	110

### Accessories

146HD	Hand pump spout to garden hose thread adapter	1
1HPS	Hand Pump Screen Adapter Kit for Spout	

### TABLE OF HAND PUMP DATA

Depth to water that can be pumped by average person and showing the three columns possible with 5", 7-1/2" and 10" pin positions on the pump handle.

Cylinder Size	5" Stroke Depth to Water-Ft.	7-1/2" Stroke Depth to Water-Ft.	10" Stroke Depth to Water-Ft.
2	201	140	108
2-1/2	141	99	76
3	104	72	56

NOTE: Above calculations are based on 50 lbs. applied perpendicular to the pump handle and includes the hydraulic lift with 10% added for leather friction and weight of rod at minimum mechanical advantage which occurs at midstroke.

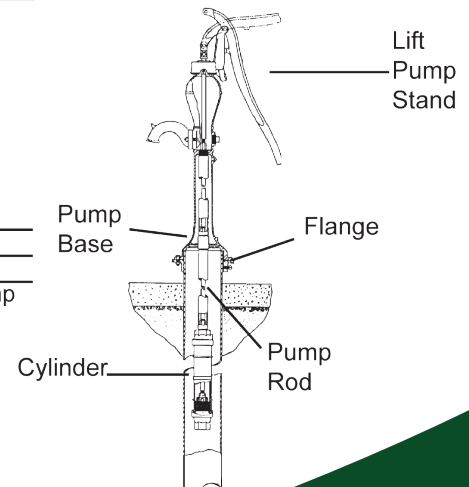

Bibb Spout



1HPS



146HD



Siphon Spout

For more information contact:

Baker Water Systems

Phone: 800-356-5130

e-mail: [monitor@baker-mfg.com](mailto:monitor@baker-mfg.com)

[www.baker-mfg.com](http://www.baker-mfg.com) | [www.campbellmfg.com](http://www.campbellmfg.com)



## DRINKING FOUNTAIN PUMPS

Table of Hand & Drinking Fountain Pump Specifications\*

Order Number	Type	Stroke Length		Drop Pipe Tapping	Spout	Rod Size	Rod Thread
		Hand	Power				
11HD	Force	5-7 1/2-10	11	1-1/4	Syphon	7/16	7/16-14NC
11HDA	Force	5-7 1/2-10	11	2	Syphon	7/16	7/16-14NC
12HD	Force	5-7 1/2-10	11	1-1/4	Bibb	7/16	7/16-14NC
12HDA	Force	5-7 1/2-10	11	2	Bibb	7/16	7/16-14NC
11HA	Lift	6	--	1-1/4	Syphon	7/16	Set Screw
1DFHCS	Drinking Fountain	5-7 1/2-10	11	1-1/4	Fountain	7/16	7/16-14NC
1DFHFS							

\*All specifications are in inches unless otherwise noted.

The **Monitor® Drinking Fountain Pump** is used on many golf courses, campgrounds, roadside parks and picnic areas. A few strokes of the handle fills a reservoir with water which, without further pumping becomes a noiseless smooth flowing Drinking Fountain. A spring-loaded hand-lift valve allows water from the reservoir to flow out a hydrant for filling a jug or bucket. The pump stand is more secure from contamination. All interior surfaces are inclined for complete drainage. All access holes are screened for vermin resistance. The drain pipe is anchored at ground level, into the pumps concrete foundation, to prevent abuse. Rugged cast iron construction assures years of dependable service. The Drinking Fountain Pump is available in 2 models.

**1DFHCS PUMP STAND** – for cased well applications, attaches to a flange mounted on top of a well casing. A vermin resistant sealed flange is available for a 4", 5" or 6" well casing. Pump weighs 120 lbs.

**1DFHFS PUMP STAND** – for cased well applications, attaches directly to a 4", 5" or 6" well casing. The well casing extends 18" above grade. (Ohio Pattern Base Pump) Weighs 120 lbs. Pump flanges will not adapt to this style.

**158DP FOUNTAIN UNIT** – This unit replaces the reservoir and bowl on either the 1HF or 1HC Drinking Fountain Pump. Weighs 45 lbs.

**100DPS HAND PUMP SHROUD CONVERSION KIT** – This sanitary unit replaces the pump cap and flat bar, on Monitor hand pumps, 11HD, 12HD, 1DFHF, 1DFHC & 1DFHT. Recommended by many federal and state environmental agencies.

**10DP Rubber Bumper Bag Assembly** is a replacement part that is used to keep the pump handle from hitting on the pump base.

**199DP Fountain Screening Kit.** Kit contains a cover gasket, screen vent, nozzle screen, filter washer and holding spring to make the Monitor drinking fountain pumps vermin resistant.

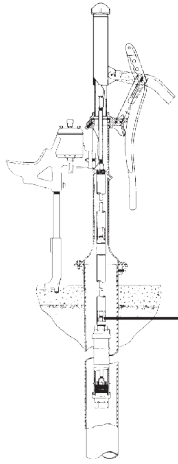

Draining "Weep" hole, approximately 1/8" to avoid freezing

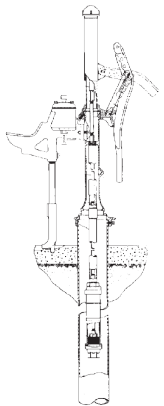

1DFHFS



100DPS

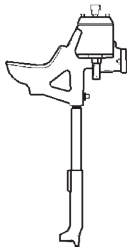

158DP

For more information contact:

Baker Water Systems

Phone: 800-356-5130

e-mail: [monitor@baker-mfg.com](mailto:monitor@baker-mfg.com)

[www.baker-mfg.com](http://www.baker-mfg.com) | [www.campbellmfg.com](http://www.campbellmfg.com)



## CYLINDERS

**ALL BRASS CYLINDER WITH FLUSH CAP**– Cylinder with brass check valve and two leather brass plunger. **NOTE: All cylinders are threaded 1-1/4" NPT.**



All Brass

Amount of Water Discharged per Stroke of a Pump			
Cylinder Size	5" Stroke Gals/Stroke	7-1/2" Stroke Gals/Stroke	10" Stroke Gals/Stroke
2"	.0680	.0952	.1360
2-1/2"	.1062	.1487	.2125
3"	.1530	.2142	.3060

### All Brass Cylinder with Flush Caps (Overall length of each cylinder is 18")

Ord. No.	Stroke	I.D.	O.D.	Wt.
00003	10	2"	2-1/2"	8.5
00004	10	2-1/2"	3"	10
00005	10"	3"	3-1/2"	13

For more information contact:  
 Baker Water Systems  
 Phone: 800-356-5130  
 e-mail: [monitor@baker-mfg.com](mailto:monitor@baker-mfg.com)  
[www.baker-mfg.com](http://www.baker-mfg.com) | [www.campbellmfg.com](http://www.campbellmfg.com)



## PUMP FLANGES AND PUMP ROD

**STANDARD PUMP FLANGES** – attaches hand pump stands with standard base to well casing. Standard pump flanges come in sizes 1” to 6”.



Standard Flange



Sealed Flange

### Standard Pipe Flanges

Ord. No.	I.D. Size	Weight
10MP	1”	9
11MP	1-1/4”	9
13MP	2”	9
14MP	2-1/2”	9
15MP	3”	9
16MP	4”	11
17MP	5”	11
18MP	6”	11

**SEALED FLANGES** – attaches hand pump stands with standard base to well casing. Sealed pump flanges come in sizes 4”, 5” and 6”.

### Sealed Pipe Flanges

Ord. No.	I.D. Size	Weight
64MP	4”	12
65MP	5”	13
66MP	6”	13

### PLATED PUMP ROD



PUMP ROD

Pump Rod	Type	Ft./Bundle	Wt./Bundle
7/16” X 18’	Plain End	198’	102
7/16” X 21’		189’	97
7/16” X 18’	Threaded & Coupled 14 NC Thread	198’	102
7/16” X 21’		189’	97
HA20	7/16”x84” Long, plated, TBE		

### FEMALE ROD COUPLINGS

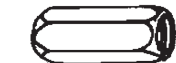

ROD COUPLINGS

Size	Weight
7/16” x 7/16”	.09
3/8” x 7/16”	.11

For more information contact:  
 Baker Water Systems  
 Phone: 800-356-5130  
 e-mail: [monitor@baker-mfg.com](mailto:monitor@baker-mfg.com)  
[www.baker-mfg.com](http://www.baker-mfg.com) | [www.campbellmfg.com](http://www.campbellmfg.com)

# Monitor

## 100LAS HAND PUMP DIVERTER

Monitor's NEW Hand Pump Diverter can be used to refill your water storage tank with water by just pumping the handle on your hand pump. No need to worry whether you have electricity or not. By pumping the handle on the hand pump you can keep your water tank full and you will be able to use all of your normal facilities in your home. The Hand Pump Diverter can be used on any Monitor spool type pitless or pitless adapter that can accommodate a hole drilled in the top for the pump rod to go through.

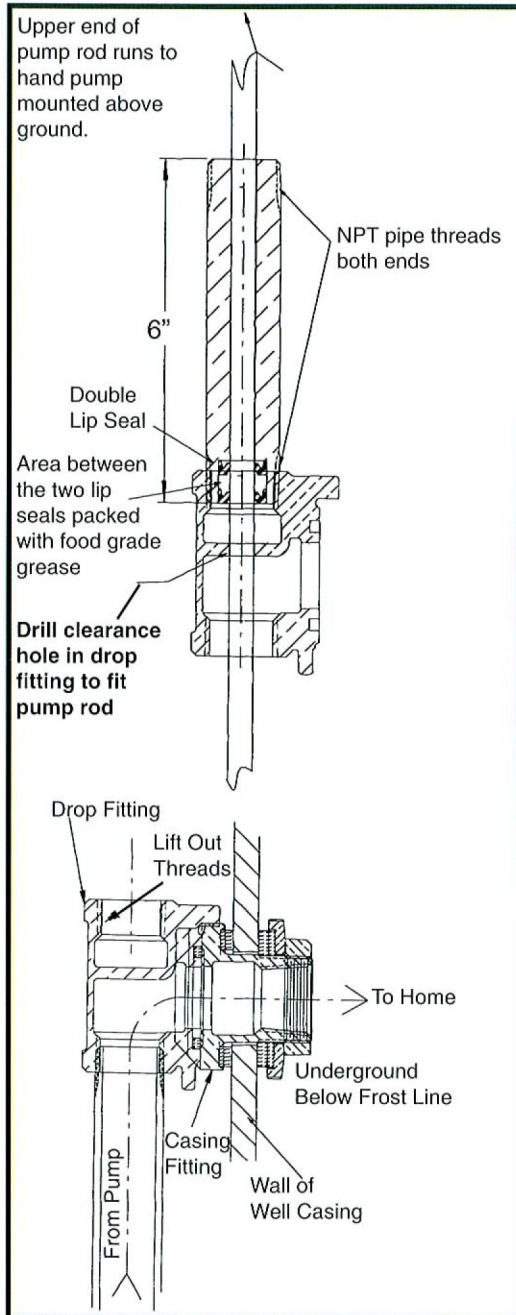

See Chart on reverse for hand pump and cylinder data information.

**BAKER**  
manufacturing company  
monitor division

**NOTE:** No water will come out the spout. The Hand Pump Diverter, diverts the water to a storage tank.

**NOTE:** Install diverter with lip seal end, screwed into the top of spool type pitless unit or pitless adapter.

**NOTE:** In place of the adapter, a spool type pitless can be used like the one shown below.

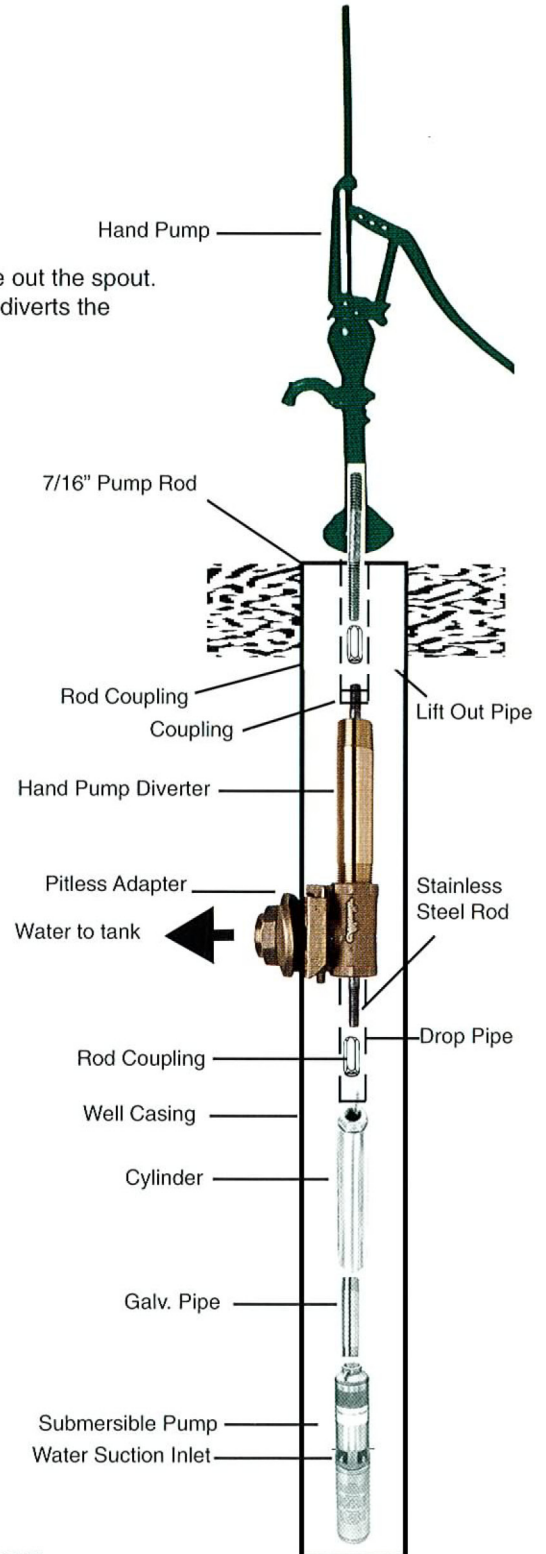
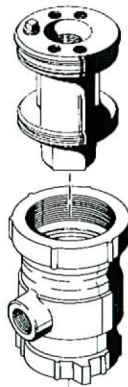

**Patent Pending**

**Baker Manufacturing Company**  
Evansville, WI 53536 • Phone: 608-882-2730